

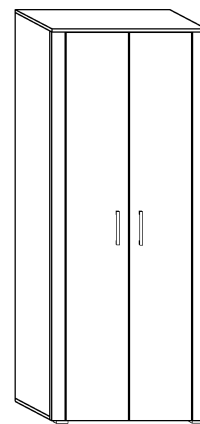

NOT-07
NOTTI - SZAFKA
 → 80 ↑ 205 ↘ 56



x 8

(a)

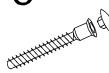

x 12

(b)



x 18

(c)

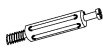

x 18

(d)



x 6

(e)

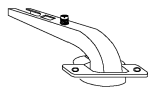

x 6

(f)

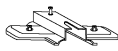

x 2

(g)



x 2

(j)



x 8

(4x20)

(k)



x 20

(3,5x16)

(l)



x 80

(m)



x 1

(n)



45 min

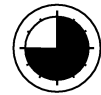
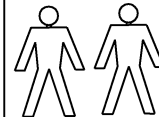

x 4

(h)

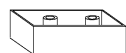

X 1 (762 mm)

(i)

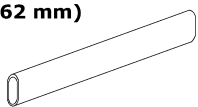

① - FAZY MONTAŻU

Ⓐ - OZNACZENIE ELEMENTÓW

ⓐ - OZNACZENIE AKCESORIÓW

①

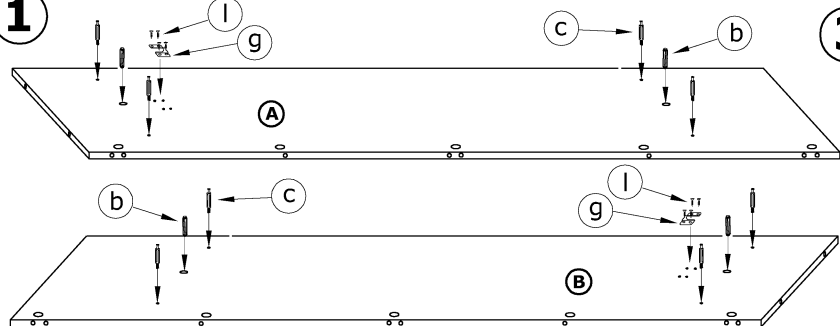

③

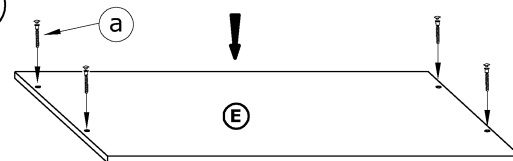

②

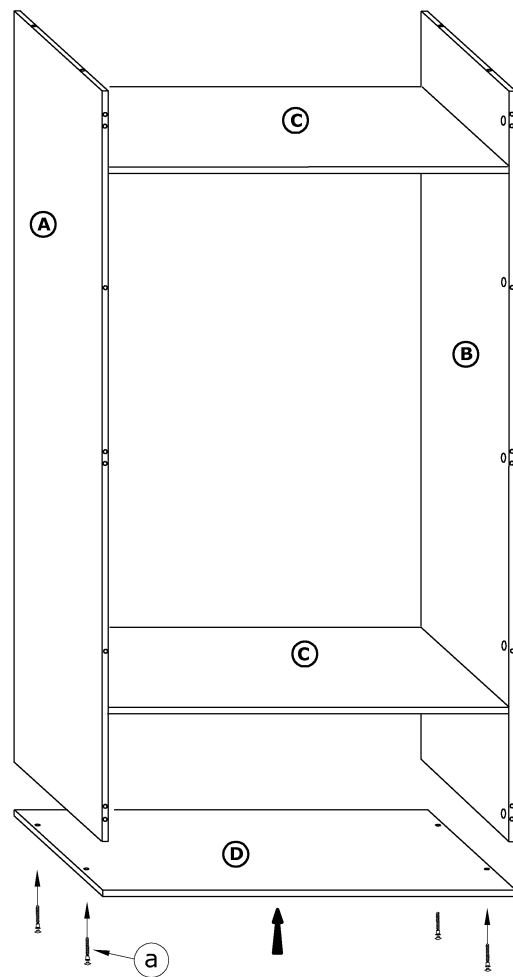
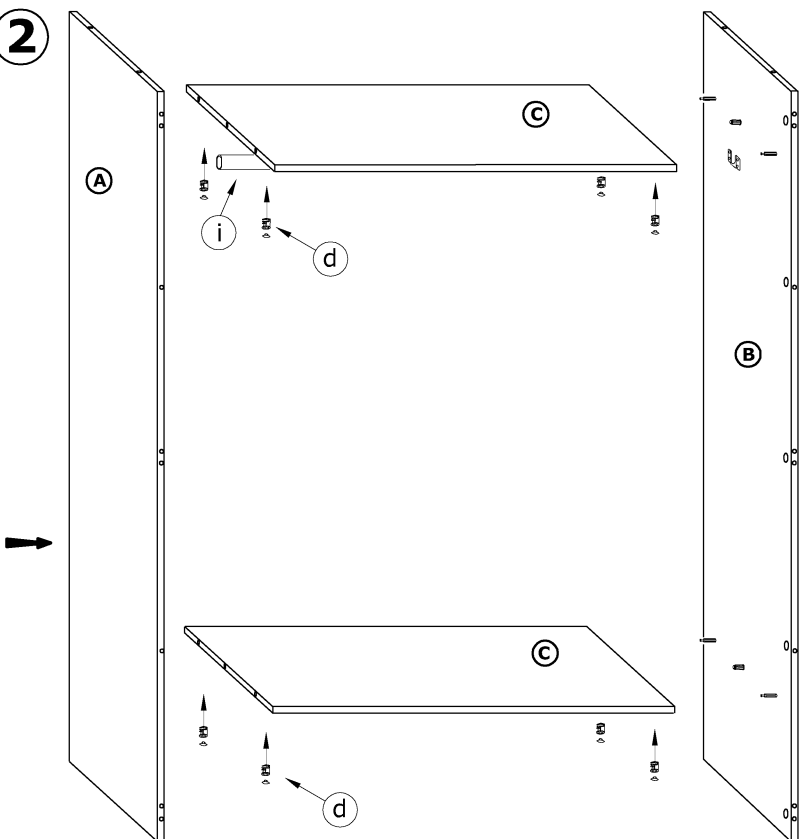

4

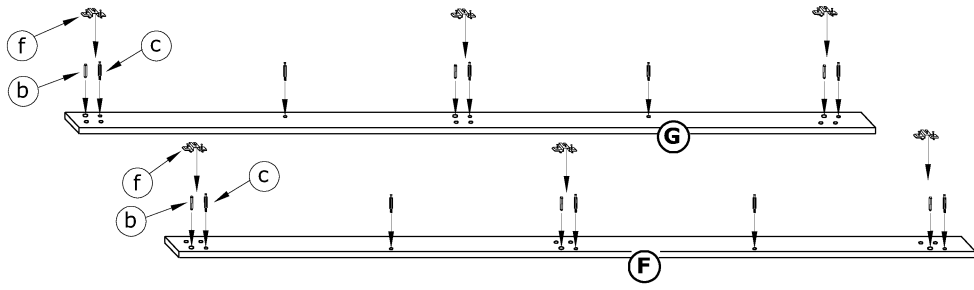

5

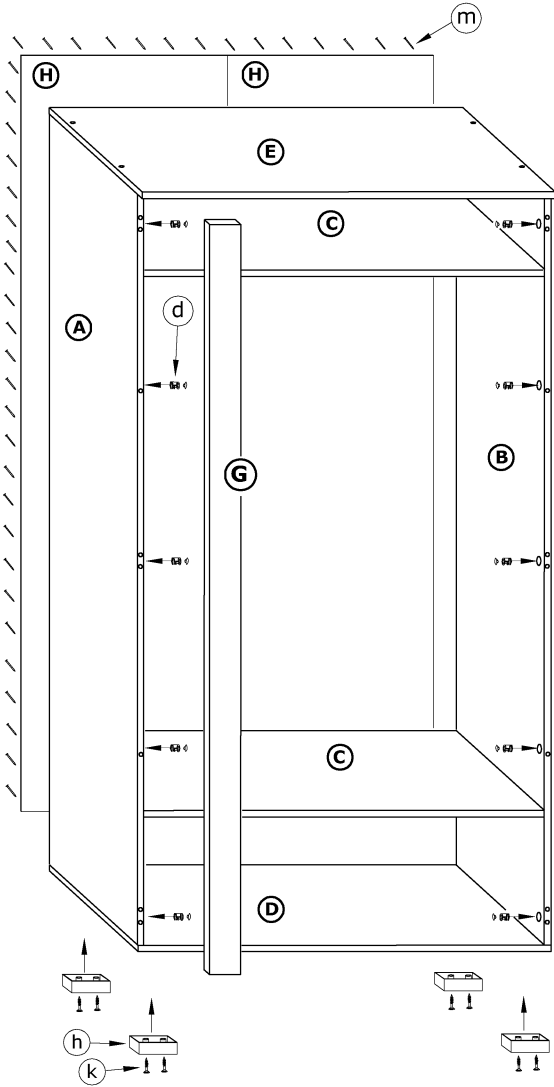

6

