

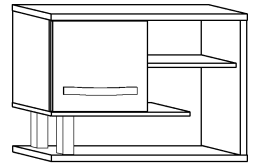

ANG-14 ANGEL- SZAFKA WISZĄCA 1D

→ 80 + 60 ↘ 33



x 16 		x 12 		x 4 		x 2 		x 2 				
x 2 kpl. 		x 4 (3,5x16) 		x 4 (6,2x13) 		x 2 (4x25) 		x 2 		x 20 		x 1
x 2 186 mm 		x 2 160 mm 		x 1 						40 min 		

① - FAZY MONTAŻU

Ⓐ - OZNACZENIE ELEMENTÓW

Ⓐ - OZNACZENIE AKCESORIÓW

1

x 2 x 2

2

x 10

3

x 2 x 2

x 2







x 4 (6,2x13)

4

x 2



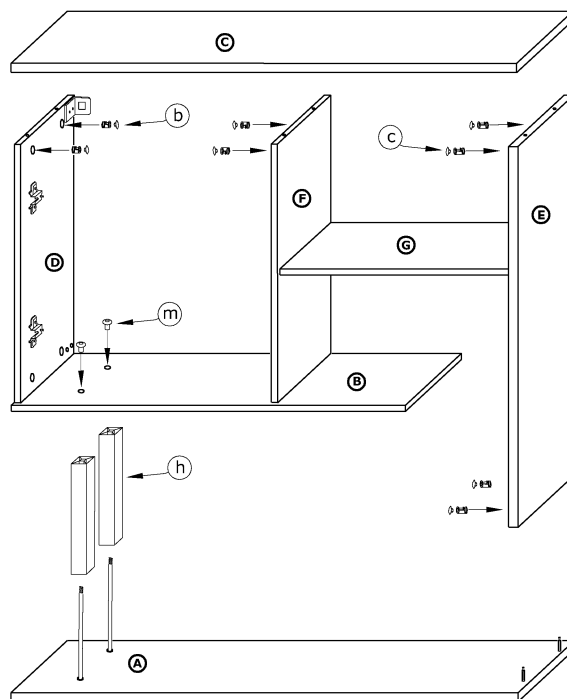

x 8

5

- x 4 
- b x 4 
- c x 4 
- X 2 160mm 
- h x 2 
- x 2 



6

- x 2 
- e x 1 
- i x 4 (3,5x16) 
- j x 2 (4x25) 
- l x 20 
- n 